



Argenta Plus

■ FLOOR-STANDING CABINETS

The Floor-Standing Cabinets of the Argenta-Plus series comprise a set of industrial metal enclosures designed to contain any type of electrical devices and equipment necessary for the supply, distribution and conversion of electricity, and suitable for control and automation equipment for industrial plants and machine tools.

This range of cabinets has been designed for maximum versatility, so that the installer can implement their own arrangements depending on their needs. Functionality is high thanks to the various possibilities for linking cabinets together, the possibility of installing any type of electrical devices, and the complete range of accessories available for this series.

Intended for the most professional sector, the range is available in two versions: COMBINABLE, supplied ready-assembled, and COMPACT. Both are available in opaque-and transparent-door versions. They are made from high-quality materials, in cold-rolled steel sheeting, achieving protection degree IP55, and a height of up to 2.200 mm.

TECHNICAL DATA

■ degree of protection	IP55
■ resistance to impact	IK10*
■ range of temperature under normal conditions	-25°C/+40°C
■ maximum operation voltage (Ue)	1000 V
■ materials	Cold-rolled steel sheeting
■ colour	RAL 7035

According to directive 2006/95/CE and regulations UNE-EN 62208 and UL508A.

The technical features described above are achieved using the components of the whole, and the accessories supplied by IDE, mounted and assembled according to the corresponding technical guidelines and instruction sheets.

* Except transparent doors: IK09

technical FEATURES

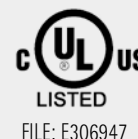

■ PRODUCT RANGE:

- **Compact Cabinets**
- Combinable Cabinets supplied **ready-assembled**

■ SIZES AVAILABLE:

- **Height:** 1.650 - 1.800 - 2.000 - 2.200 mm
- **Width:** 600 - 800 - 1.000 - 1.200 - 1.600 mm
- **Depth:** 400 - 500 - 600 - 800 mm

■ MATERIALS:

- **CASE:** 1,5 mm cold-rolled steel sheeting, RAL 7035
- **BACK PANEL, TOP & BOTTOM COVERS:** 1,5 mm cold-rolled steel sheeting. The back panel is covered with a gasket which guarantees IP55 protection degree
- **SIDE PANELS:** 1,5 mm cold-rolled steel sheeting, (for combinable cabinets)
- **OPAQUE DOORS:** 2 mm cold-rolled steel sheeting
- **TRANSPARENT DOORS:** 4 mm tempered glass
- **HINGES, LOCKS & RETAINERS:** Strengthened Zamak
- **MOUNTING PLATES:** 3 mm galvanised sheeting, strengthened by fold

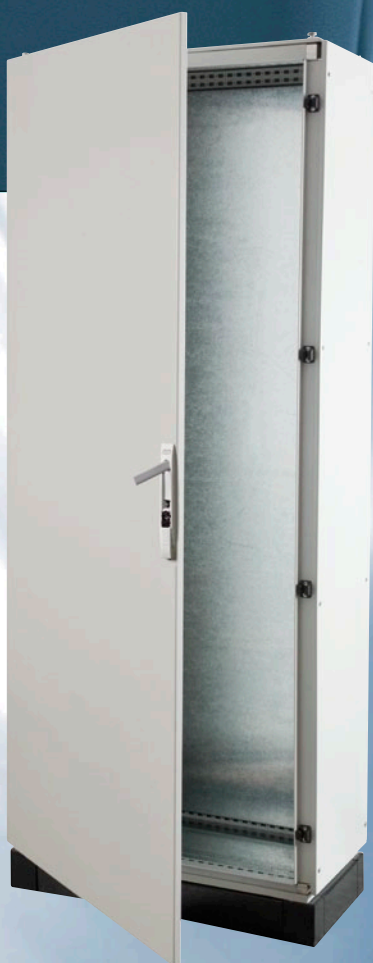

technical FEATURES

MOUNTING PLATES

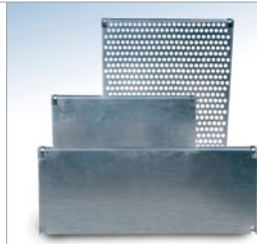

- Made in 3 mm sheeting, strengthened by folds.
- Types of plate available:
 - Complete flat
 - Partial flat
 - Partial slotted
 - Linking for combinable cabinets
 - Separating for combinable cabinets
- The corresponding bag of assembly components must be requested for additional plates requested as accessories.

MODULAR FRAME



- Needed for attaching DIN rail adjustment components & front covers
- Two vertical profiles & two horizontal profiles supplied for 600 & 800 mm width cabinets
- Four vertical profiles & two horizontal profiles plus profile & dividing door supplied for 1.000 & 1.200 mm width cabinets

PLINTH

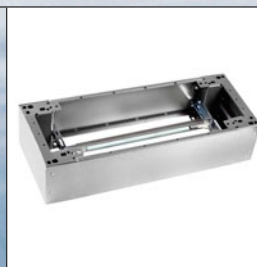

- Supplied as accessory. Corners and front and rear cover are supplied in one batch, and side panels in another
- Available in two heights: 100 mm, 200 mm
- The 200 mm plinth can also be supplied with a 100+100 cover

MODULAR COVERS



- Supplied as accessories. Available in the following versions:
 - Modular hinged
 - Blank hinged
 - Modular fixed
 - Blank fixed
- Joined to cabinet frame by M6 cage nut and M6x10 anti-twist bolts



TRUNKING SUPPORT

- Space for vertical trunking up to 60x60 mm
- DIN rail capacity:
 - 18 modules for 600 mm wide covers
 - 28 modules for 800 mm wide covers
- Inter-combinable vertical and horizontal trunking supports
- Two fastening positions for horizontal trunking for separation between DIN rails of 150 or 200 mm

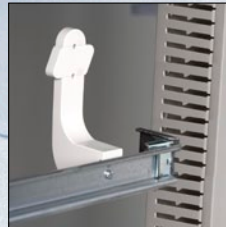

HORIZONTALS PROFILES

- To attach partial plates or other electrical accessories at various depths



Profile for frame

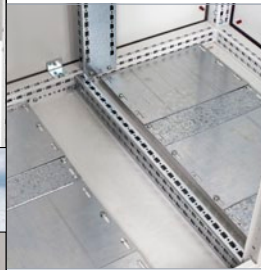

Interior partition profile



Possibility to install the profiles in every direction and position as to form internal structures

DIN RAIL

- Adjustable distance, allowing any type of electrical devices to be installed
- Assembly supports and DIN rail, flat or slotted, supplied separately



DOORS

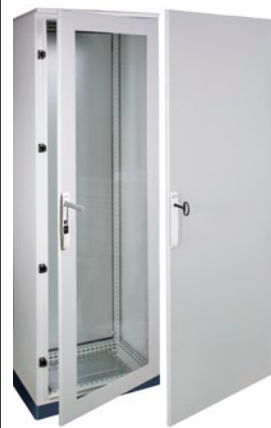

- Available in opaque and transparent versions
- Opaque version made in 2 mm sheeting with reinforcement profiles
- Transparent version in 4 mm tempered glass
- All doors reversible
- 120° door opening

REINFORCEMENT PROFILES

Installed on opaque doors. Provide rigidity and allow electrical devices to be attached



ACCESORIES



PC tray

technical FEATURES

LOCKS

- Standard four-point, 1/4-turn lock, double-bit insert, with retractable handle in grey RAL 7035
- Other locks can be supplied as accessories



Triangular insert lock plus triangular key



Keyless pressure insert lock



Safety insert lock with key

DOOR HINGES & RETAINERS

Hinge made in strengthened Zamak, allowing 120° opening



Single door retainer made in strengthened Zamak



Double door retainer



COMPACT CABINETS ■

■ CASE



■ Single-component, welded and consisting of:

- Closed sides in 1,5 mm sheeting
- External profiles which have a tubular structure, making the cabinet highly resistant
- Metal pieces welded inside the structure of the cabinet to support lifting eye bolts at the top and secure the base at the bottom



■ REAR PANEL



- Made in 1,5 mm sheeting
- Gasket guarantees IP55 protection
- Reversible and replaceable via one door
- Attached by countersunk screws



■ TOP COVER



- Made in 1,5 mm sheeting
- Gasket guarantees IP55 protection
- Includes M8 bolts for earth connection
- Supplied with two eyebolts for easy lifting



■ DOORS FOR COMPACT CABINET



- Available in opaque & transparent versions
- Opaque version made in 2 mm sheeting with reinforcement profiles which ensure high rigidity and allow accessories to be attached to the door
- Transparent version in 4 mm tempered glass
- Double doors for 1.000 and 1.200 mm cabinets, opaque or transparent
- All doors reversible
- Standard four-point, 1/4-turn lock with retractable handle in strengthened Zamak

■ CABLE ENTRY COVER

- Adjustable, interchangeable covers
- Lids of 100 and 200 mm depending on the depth of the cabinet



■ DOUBLE DOORS FOR COMPACT CABINET



- OPAQUE DOUBLE-DOOR CABINETS WITH DOUBLE INTERNAL LOCK
 - Double door for 1.000 and 1.200 mm-width cabinets
 - 1.000 mm door: 500 mm opaque door + 500 mm opaque door
 - 1.200 mm door: 600 mm opaque door + 600 mm opaque door
- TRANSPARENT DOUBLE-DOOR CABINETS WITH DOUBLE INTERNAL LOCK
 - Double door for 1.000 & 1.200 mm-width cabinets
 - 1.000 mm door: 600 mm transparent door + 400 mm opaque door
 - 1.200 mm door: 800 mm transparent door + 400 mm opaque door

SINGLE-DOOR COMPACT CABINETS ■

Front

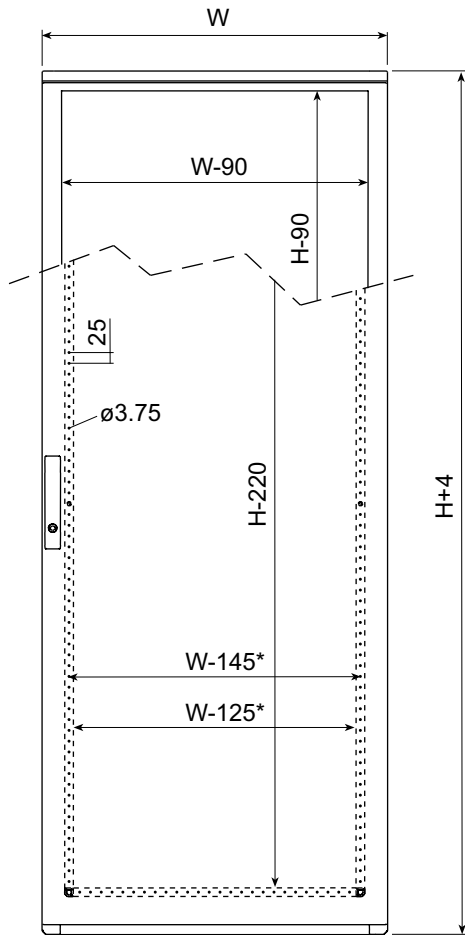

Side section

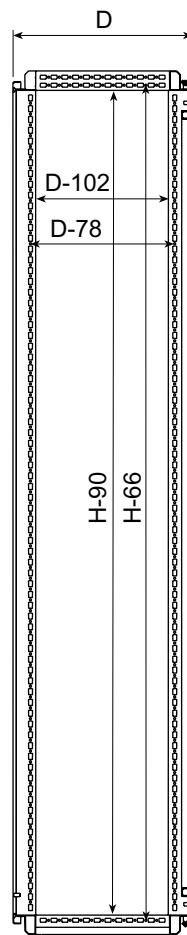

Mounting plate

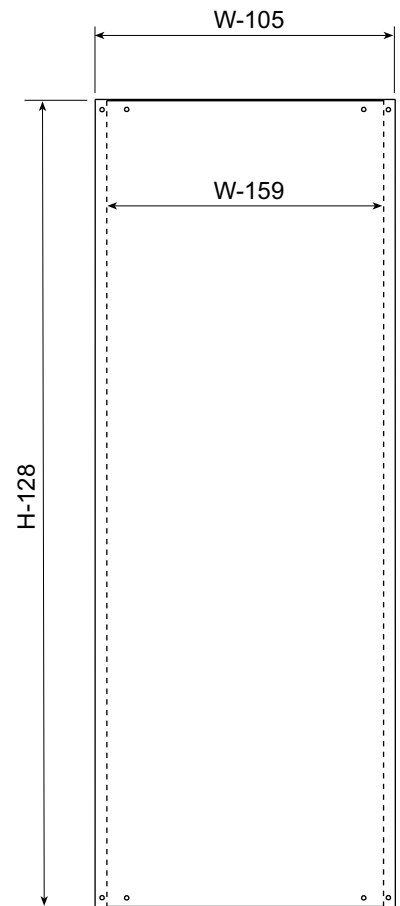

Ground plan

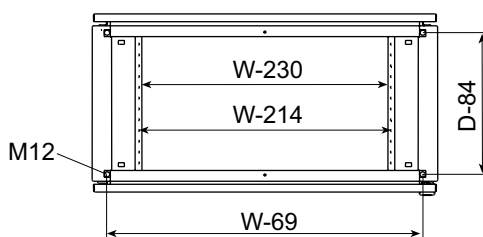

Ground plan section

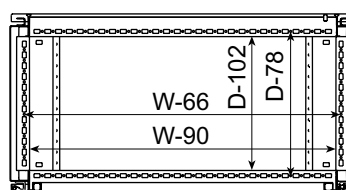

Profile

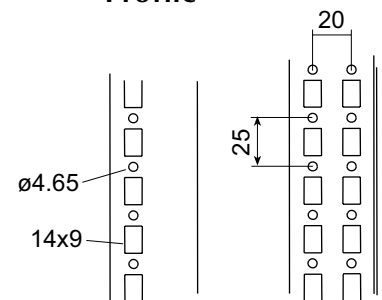

(*) For W=600, change to W-170
W-150

H	W	D	H	W	D	H	W	D
1.650	600	412	1.800	600	412	2.000	600	412
	800			800			800	
	1.000			1.000			1.000	
			1.800	800	512	2.000	800	512
				1.000			1.000	

Height(H) x Width(W) x Depth(D). Dimensions in mm

DOUBLE-DOOR COMPACT CABINETS

Front

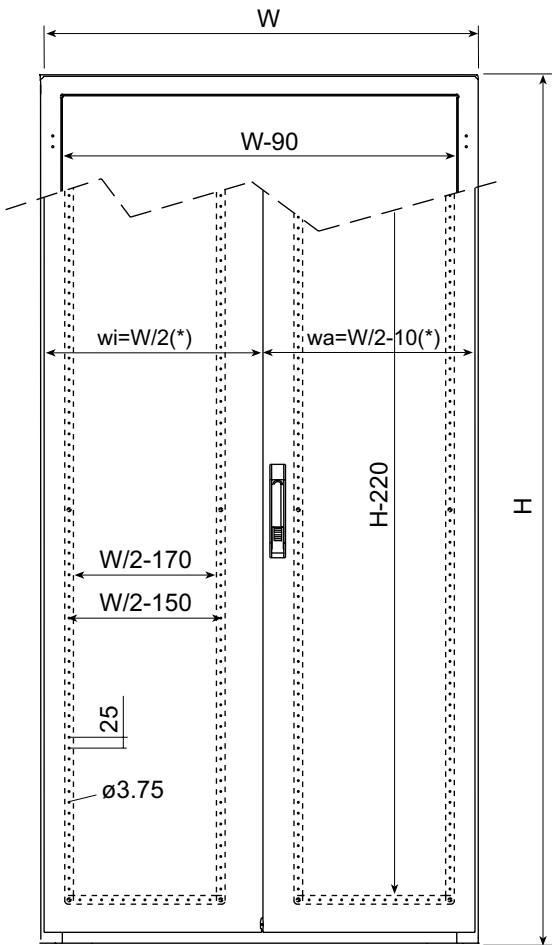

Side section

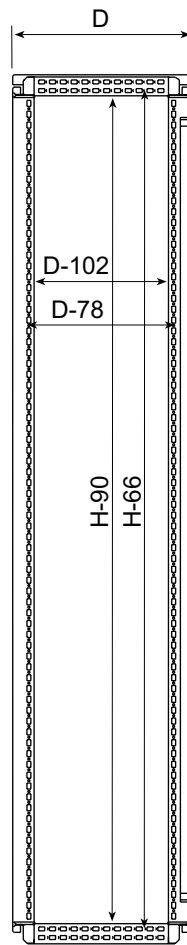

Mounting plate

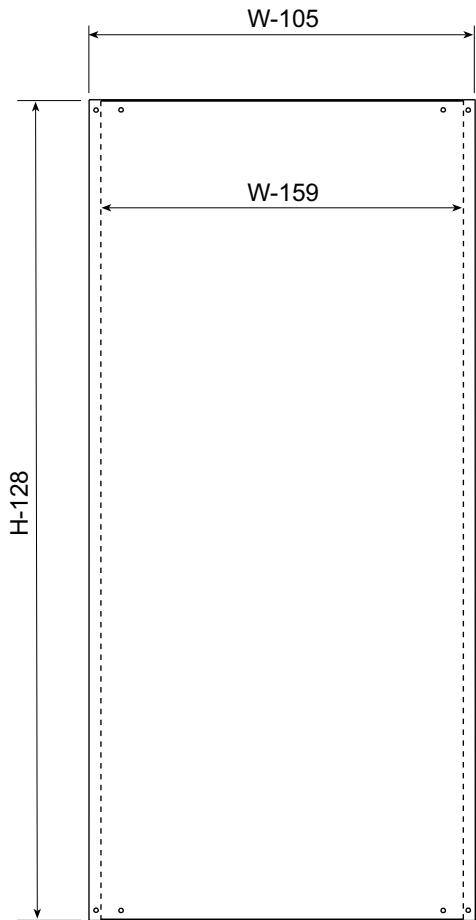

Ground plan

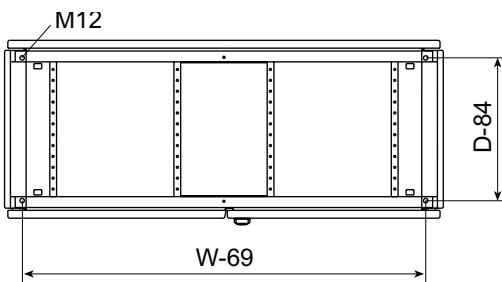

Ground plan section

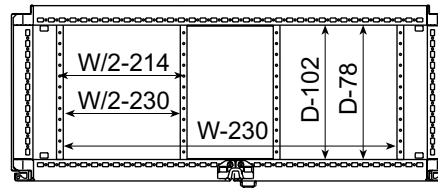

Profile

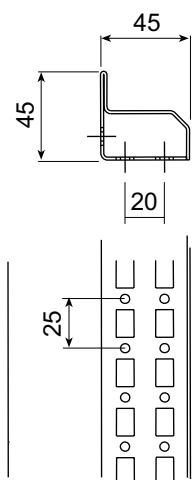

(*) For asymmetrical doors $W=1000$, $w_i=400$, $w_a=590$
 $W=1200$, $w_i=400$, $w_a=790$

ø4.65

14x9

H	W	D	H	W	D	H	W	D
1.650	1.000	412	1.800	1.000	412	2.000	1.000	412
	1.200			1.200				
			1.800	1.200	512	2.000	1.200	512

Height(H) x Width(W) x Depth(D). Dimensions in mm

COMPACT CABINETS ■



■ OPAQUE DOOR CABINETS WITH NO PLATE

Commercial Ref.

Dimensions (Height x Width x Depth)

Commercial Ref.	Dimensions (Height x Width x Depth)		
FSC1656040PO/SP	1.650	600	400
FSC1658040PO/SP	1.650	800	400
FSC16510040PO/SP	1.650	1.000	400
FSC16512040PO/DC*	1.650	1.200	400
FSC1806040PO/SP	1.800	600	400
FSC1808040PO/SP	1.800	800	400
FSC1808050PO/SP	1.800	800	500
FSC18010040PO/SP	1.800	1.000	400
FSC18010050PO/SP	1.800	1.000	500
FSC18012040PO/DC*	1.800	1.200	400
FSC18012050PO/DC*	1.800	1.200	500
FSC2006040PO/SP	2.000	600	400
FSC2008040PO/SP	2.000	800	400
FSC2008050PO/SP	2.000	800	500
FSC20010040PO/SP	2.000	1.000	400
FSC20010050PO/SP	2.000	1.000	500
FSC20012040PO/DC*	2.000	1.200	400
FSC20012050PO/DC*	2.000	1.200	500

See dimensions on pages 33-34

* Opaque double door with double internal lock

■ TRANSPARENT DOOR CABINETS WITH NO PLATE

Commercial Ref.

Dimensions (Height x Width x Depth)

Commercial Ref.	Dimensions (Height x Width x Depth)		
FSC1656040PT/SP	1.650	600	400
FSC1658040PT/SP	1.650	800	400
FSC16510040PT/DC*	1.650	1.000	400
FSC16512040PT/DC*	1.650	1.200	400
FSC1806040PT/SP	1.800	600	400
FSC1808040PT/SP	1.800	800	400
FSC1808050PT/SP	1.800	800	500
FSC18010040PT/DC*	1.800	1.000	400
FSC18010050PT/DC*	1.800	1.000	500
FSC18012040PT/DC*	1.800	1.200	400
FSC18012050PT/DC*	1.800	1.200	500
FSC2006040PT/SP	2.000	600	400
FSC2008040PT/SP	2.000	800	400
FSC2008050PT/SP	2.000	800	500
FSC20010040PT/DC*	2.000	1.000	400
FSC20010050PT/DC*	2.000	1.000	500
FSC20012040PT/DC*	2.000	1.200	400
FSC20012050PT/DC*	2.000	1.200	500

Door 1000: PT600 + P0400
Door 1200: PT800 + PT400

See dimensions on pages 33-34

* Transparent double door with double internal lock

THESE CODES DON'T INCLUDE THE MOUNTING PLATE. SEE MOUNTING PLATES ON PAGE 47
PLINTH SUPPLIED AS AN ACCESSORY

■ READY-ASSEMBLED COMBINABLE CABINETS

Combinable cabinets can be supplied ready-assembled in the following versions:

- Opaque door without plate
- Transparent door without plate

Supplied without side panels. Side panels must therefore be requested apart.



■ DOUBLE DOOR FOR COMBINABLE CABINETS



■ TRANSPARENT DOUBLE-DOOR CABINETS WITH DOUBLE INTERNAL LOCK

Door for 1.000 & 1.200 mm-width cabinets

1.000 mm door: 600 mm transparent door + 400 mm opaque door

1.200 mm door: 800 mm transparent door + 400 mm opaque door

■ OPAQUE DOUBLE-DOOR CABINETS WITH DOUBLE INTERNAL LOCK

Double door for 1.000, 1.200 and 1.600 mm-width cabinets

1.000 mm door: 500 mm opaque door + 500 mm opaque door

1.200 mm door: 600 mm opaque door + 600 mm opaque door

1.600 mm door: 800 mm opaque door + 800 mm opaque door

■ LINKING SYSTEM FOR COMBINABLE CABINETS



VARIOUS POSSIBILITIES for linking combinable cabinets, achieving high-capacity structures at the height of any electrical installation



INTERNAL LINKING COMPONENTS supplied as accessories. Items made in 3 mm steel which, joined to the cabinet, guarantee absolute robustness of the structure

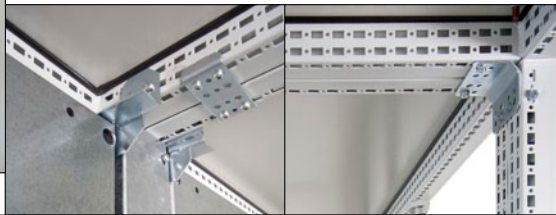

JOINING AND LIFTING SYSTEM for combinable cabinets, supplied as an accessory. Cabinets have additional reinforcement at the points of the structure which will support strains from transport



■ CORNER MODULES

■ APPLICATION

The corner module is ideal for linking cabinets where space is limited



■ STRUCTURE

The corner module consists of the following components:

- 1 structural frame
- 1 top cover
- 1 rear panel
- Adjustable cable input covers
- Screws and assembly fittings

■ SIZES

Available from 1.800x400x400 to 2.000x800x800



AUXILIARY MODULE ■



■ APPLICATION

The auxiliary module allows to create an area within the structure, especially designed for placing bus-bars vertically or small input switches



■ SIZES

The auxiliary module has a width of 400 mm and is available from 1.800x400x400 to 2.000x400x800 for all possible dimensions of combined cabinets



■ ACCESSORIES

FRONT COVERS

The front door covers close the front of the auxiliary module. They are available in different sizes for installing different size sections and for partially or totally opening the front

■ SWING FRAME



19" Swing frame available:

- 1.800 mm: 36 U
- 2.000 mm: 40 U
- 2.200 mm: 45 U

The unit is supplied fully assembled. Each of the following items must be ordered individually:
CABINET + SIDE PANEL + MOUNTING PLATE + SWING FRAME



Reversible frame, opens right or left, with maximum opening of 180°. Retainer to secure the chassis frame in the open position, as standard



Protective cover built into the unit to cover the extra space for placing control and signalling components

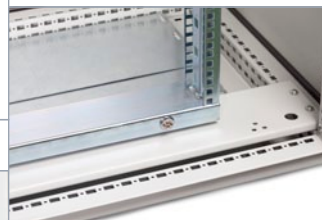

Frame can accept a standard swing lock if the handle lock assembly cannot be used for structural reasons

Pressure insert lock as standard with other types of inserts available as accessories



Steel axis-hinge system to ensure the stability of the swing rack when fully loaded

FIXED FRAME ■

19" Fixed frame available for cabinets:

- 1.800 mm: 39 U
- 2.000 mm: 43 U
- 2.200 mm: 48 U

The unit is supplied fully assembled. Each of the following items must be ordered individually:

CABINET (pages 45-46) +
SIDE PANELS (page 47) +
FIXED FRAME PROFILE (page 53) +
FIXING BRACKETS (page 53) +
FINISHING LIDS (page 53) +
ASSEMBLY PROFILES (page 57)



Highly robust, strong supports. Can be clipped on to the finishing lids



High strength 3-fold profile. Punched at the front and side of the cabinet for 19" units



Finishing lids to cover the side wiring, attached with clips to the profile supports



■ ENCLOSURE FOR BUS-BARS SYSTEM

- This accessory is designed to install the bus-bars system inside and out of the enclosure itself, where the available space is optimised at the maximum
- It can be placed on the top or at the bottom of the enclosure. All its components are reversible, which makes the installation easy and quick

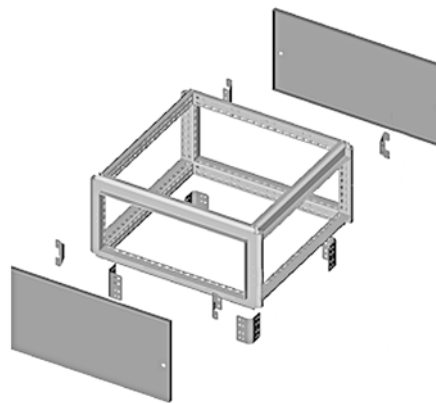

COMPONENTS:

- Welded structure composed of profiles and corners
- 2 panels + 4 supports
- Corner joining kit (48112)
- Assembly screws

SINGLE-DOOR COMBINABLE CABINETS ■

Front

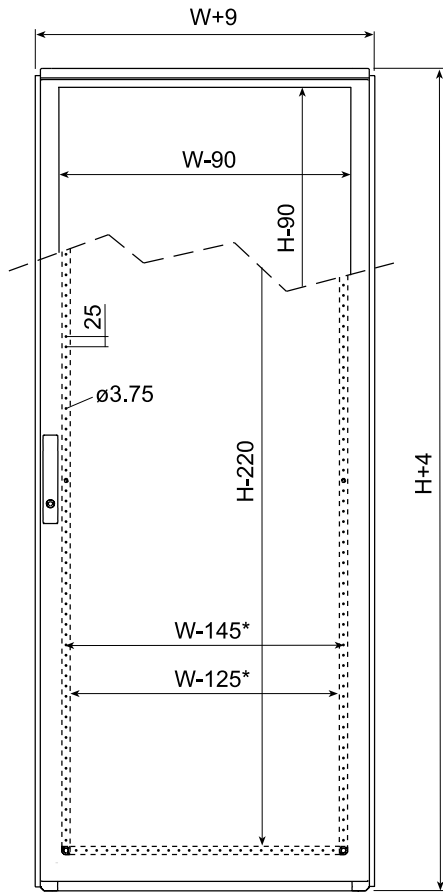

Side section

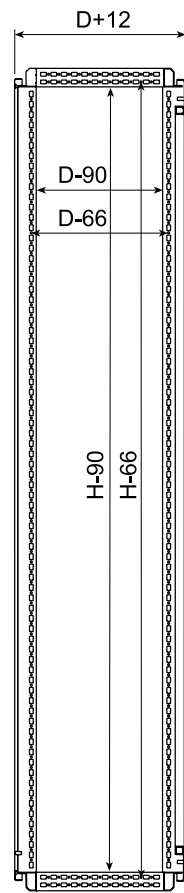

Mounting plate

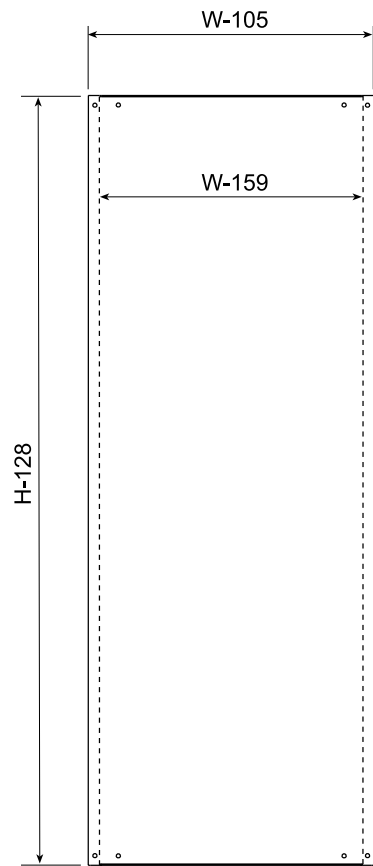

Ground plan

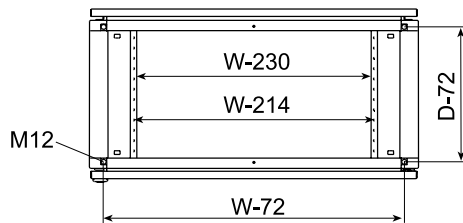

Ground plan section

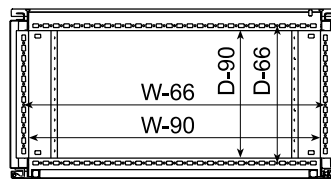

Profile

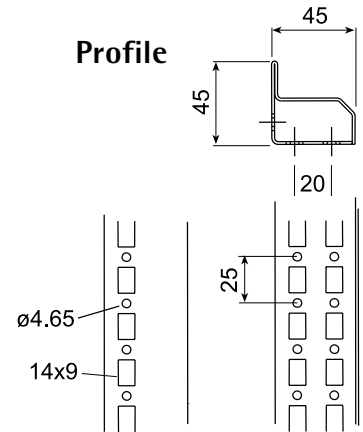

(*) For W=600, change to W-170
W-150

H	W	D	H	W	D	H	W	D		
1.800	600	400	2.000	600	400	2.200	800	600		
		500			500					
		600			600					
	800	800		400	800			800	800	800
				500						
				600						
	1.000	1.000		400	1.000			1.000	800	800
				500						
				600						

Height(H) x Width(W) x Depth(D).
Dimensions in mm

DOUBLE-DOOR COMBINABLE CABINETS

Front

Side section

Mounting plate

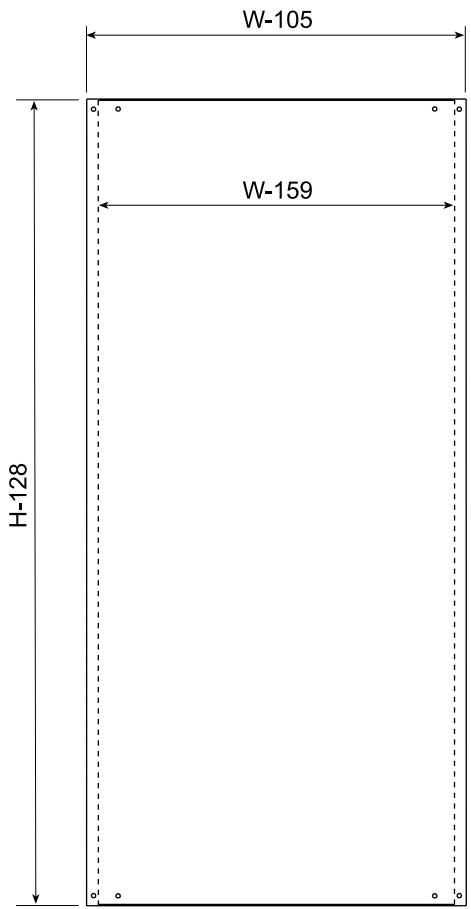
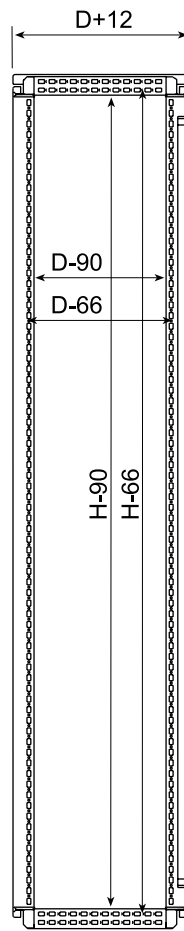
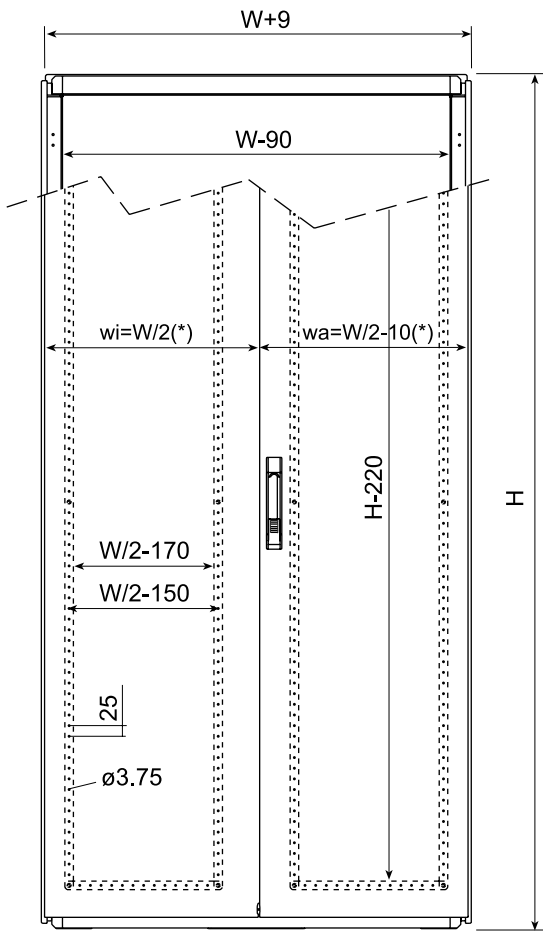

Ground plan

Ground plan section

Profile

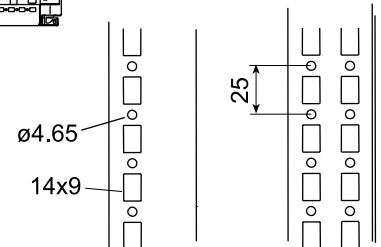
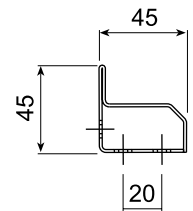
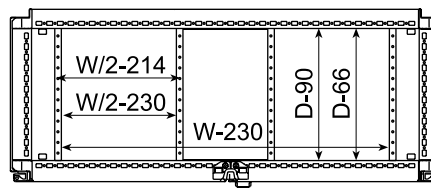
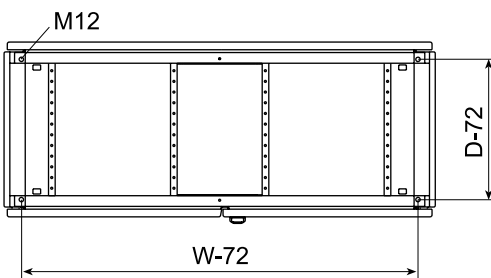

(*) For asymmetrical doors $W=1000$, $w_i=400$, $w_a=590$
 $W=1200$, $w_i=400$, $w_a=790$

H	W	D	H	W	D		
1.800	1.000	400	2.000	1.000	400		
		500			500		
		600			600		
	1.200	1.200		400	1.200	400	
				500		500	
				600		600	
		1.600		1.600	400	1.600	400
							800
							500

Height(H) x Width(W) x Depth(D). Dimensions in mm

READY-ASSEMBLED COMBINABLE CABINETS ■



OPAQUE DOOR CABINETS WITH NO PLATE ■

These codes don't include the side panels and the mounting plate (See references on page 47)



PLINTH SUPPLIED AS AN ACCESSORY

Commercial Ref.	Dimensions (Height x Width x Depth)		
ENL1806040PO/SP	1.800	600	400
ENL1806050PO/SP	1.800	600	500
ENL1806060PO/SP	1.800	600	600
ENL1808040PO/SP	1.800	800	400
ENL1808050PO/SP	1.800	800	500
ENL1808060PO/SP	1.800	800	600
ENL18010040PO/SP	1.800	1.000	400
ENL18010050PO/SP	1.800	1.000	500
ENL18010060PO/SP	1.800	1.000	600
ENL18012040PO/DC*	1.800	1.200	400
ENL18012050PO/DC*	1.800	1.200	500
ENL18012060PO/DC*	1.800	1.200	600
ENL18016040PO/DC*	1.800	1.600	400
ENL18016050PO/DC*	1.800	1.600	500
ENL2006040PO/SP	2.000	600	400
ENL2006050PO/SP	2.000	600	500
ENL2006060PO/SP	2.000	600	600
ENL2006080PO/SP	2.000	600	800
ENL2008040PO/SP	2.000	800	400
ENL2008050PO/SP	2.000	800	500
ENL2008060PO/SP	2.000	800	600
ENL2008080PO/SP	2.000	800	800
ENL20010040PO/SP	2.000	1.000	400
ENL20010050PO/SP	2.000	1.000	500
ENL20010060PO/SP	2.000	1.000	600
ENL20010080PO/SP	2.000	1.000	800
ENL20012040PO/DC*	2.000	1.200	400
ENL20012050PO/DC*	2.000	1.200	500
ENL20012060PO/DC*	2.000	1.200	600
ENL20012080PO/DC*	2.000	1.200	800
ENL20016040PO/DC*	2.000	1.600	400
ENL20016050PO/DC*	2.000	1.600	500
ENL2208060PO/SP	2.200	800	600
ENL2208080PO/SP	2.200	800	800

See dimensions on pages 43-44

* Opaque double door with double internal lock

■ READY-ASSEMBLED COMBINABLE CABINETS

■ TRANSPARENT DOOR CABINETS WITH NO PLATE



PLINTH SUPPLIED AS
AN ACCESSORY

These codes don't include the side panels and the mounting plate (See references on page 47)

Commercial Ref.

Dimensions (Height x Width x Depth)

Commercial Ref.	Dimensions (Height x Width x Depth)
ENL1806040PT/SP	1.800 600 400
ENL1806050PT/SP	1.800 600 500
ENL1806060PT/SP	1.800 600 600
ENL1808040PT/SP	1.800 800 400
ENL1808050PT/SP	1.800 800 500
ENL1808060PT/SP	1.800 800 600
ENL18010040PT/DC*	1.800 1.000 400
ENL18010050PT/DC*	1.800 1.000 500
ENL18010060PT/DC*	1.800 1.000 600
ENL18012040PT/DC*	1.800 1.200 400
ENL18012050PT/DC*	1.800 1.200 500
ENL18012060PT/DC*	1.800 1.200 600
ENL2006040PT/SP	2.000 600 400
ENL2006050PT/SP	2.000 600 500
ENL2006060PT/SP	2.000 600 600
ENL2006080PT/SP	2.000 600 800
ENL2008040PT/SP	2.000 800 400
ENL2008050PT/SP	2.000 800 500
ENL2008060PT/SP	2.000 800 600
ENL2008080PT/SP	2.000 800 800
ENL20010040PT/DC*	2.000 1.000 400
ENL20010050PT/DC*	2.000 1.000 500
ENL20010060PT/DC*	2.000 1.000 600
ENL20010080PT/DC*	2.000 1.000 800
ENL20012040PT/DC*	2.000 1.200 400
ENL20012050PT/DC*	2.000 1.200 500
ENL20012060PT/DC*	2.000 1.200 600
ENL20012080PT/DC*	2.000 1.200 800
ENL2208060PT/SP	2.200 800 600
ENL2208080PT/SP	2.200 800 800

Door 1000: PT600 + P0400
Door 1200: PT800 + PT400

See dimensions on pages 43-44

* Transparent double door with double internal lock

Dimensions in mm

THE PACKAGING OF THE CABINET WILL INCLUDE THE SIDE PANELS AND THE MOUNTING PLATES IN CASE THEY ARE ORDERED



PLINTH SUPPLIED LIKE ACCESSORY

■ SIDE PANELS

Commercial Ref.	Cabinet dimensions (Height x Depth)	
PLA18040	1.800	400
PLA18050	1.800	500
PLA18060	1.800	600
PLA20040	2.000	400
PLA20050	2.000	500
PLA20060	2.000	600
PLA20080	2.000	800
PLA22060	2.200	600
PLA22080	2.200	800

MOUNTING PLATES ■

COMPLETE FLAT MOUNTING PLATES

Strengthened by folds which provide great rigidity. Identical for all two versions of cabinets

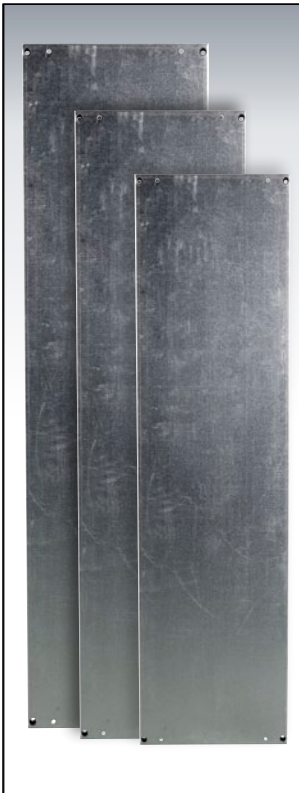

Commercial Ref.	Dimensions (Height x Width)	For Cabinet (Height x Width)	
PL16560	1.522x500	1.650	600
PL16580	1.522x700	1.650	800
PL165100	1.522x900	1.650	1.000
PL165120	1.522x1.100	1.650	1.200
PL18040	1.672x300	1.800	400
PL18050	1.672x400	1.800	500
PL18060	1.672x500	1.800	600
PL18080	1.672x700	1.800	800
PL180100	1.672x900	1.800	1.000
PL180120	1.672x1.100	1.800	1.200
PL20040	1.872x300	2.000	400
PL20050	1.872x400	2.000	500
PL20060	1.872x500	2.000	600
PL20080	1.872x700	2.000	800
PL200100	1.872x900	2.000	1.000
PL200120	1.872x1.100	2.000	1.200
PL22080	2.072x700	2.000	800

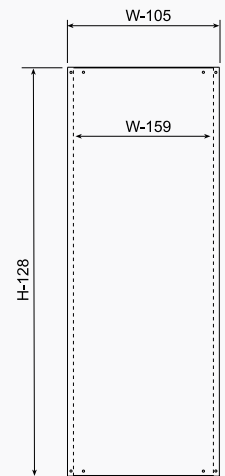

ASSEMBLY ACCESSORY BAG INCLUDED

ARGENTA PLUS accessories

■ MOUNTING PLATES



PARTIAL FLAT ASSEMBLY PLATES

Commercial Ref.	Dimensions (Height x Width)	For Cabinet (Width)
PLP2040	200x225	400
PLP2060	200x425	600
PLP2080	200x625	800
PLP3040	300x225	400
PLP3060	300x425	600
PLP3080	300x625	800
PLP30100	300x825	1.000
PLP30120	300x1.025	1.200
PLP4040	400x225	400
PLP4060	400x425	600
PLP4080	400x625	800
PLP40100	400x825	1.000
PLP40120	400x1.025	1.200
PLP6040	600x225	400
PLP6060	600x425	600
PLP6080	600x625	800
PLP60100	600x825	1.000
PLP60120	600x1.025	1.200

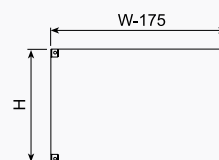

ASSEMBLY ACCESSORY BAG INCLUDED



LINKING PLATES FOR COMBINABLE CABINETS

Commercial Ref.	Dimensions (Height x Width)	For Cabinet (Height)
PLC1800	1.672x107	1.800
PLC2000	1.872x107	2.000



ASSEMBLY ACCESSORY BAG INCLUDED

MOUNTING PLATES ■



PARTIAL SLOTTED ASSEMBLY PLATES

Commercial Ref.	Dimensions (Height x Width)	For Cabinet (Width)
PLPU3040	300x225	400
PLPU3060	300x425	600
PLPU3080	300x625	800
PLPU30100	300x825	1.000
PLPU30120	300x1.025	1.200
PLPU4040	400x225	400
PLPU4060	400x425	600
PLPU4080	400x625	800
PLPU40100	400x825	1.000
PLPU40120	400x1.025	1.200
PLPU6040	600x225	400
PLPU6060	600x425	600
PLPU6080	600x625	800
PLPU60100	600x825	1.000
PLPU60120	600x1.025	1.200

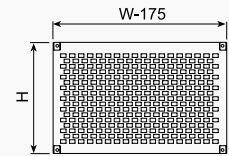

ASSEMBLY ACCESSORY BAG INCLUDED



SEPARATING PLATES FOR COMBINABLE CABINETS



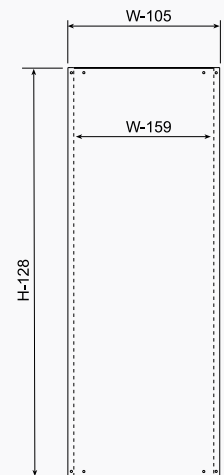

Commercial Ref.	Dimensions (Height x Width)	For Cabinet (Height x Depth)	
PLS18040	1.672x300	1.800	400
PLS20040	1.872x300	2.000	400
PLS18050	1.672x400	1.800	500
PLS20050	1.872x400	2.000	500
PLS18060	1.672x500	1.800	600
PLS20060	1.872x500	2.000	600
PLS18080	1.672x700	1.800	800
PLS20080	1.872x700	2.000	800







ASSEMBLY ACCESSORY BAG INCLUDED

ARGENTA PLUS accessories

■ PACK OF ACCESSORIES FOR ASSEMBLY PLATES

	Commercial Ref. 48471	<i>Pack of accessories to assemble the complete plate (4 units)</i>
	Commercial Ref. 48472	<i>Pack of accessories for partial plate (4 units)</i>
	48419	<i>Pack of accessories for separating plate (4 units)</i>
	Commercial Ref. 48473	<i>Pack of accessories for central support of complete plate (2 units)</i>
	Commercial Ref. 48474	<i>Pack of accessories to assemble the linking plate (2 units)</i>

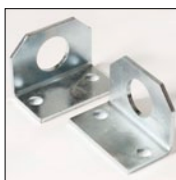
■ COMBINABLE CABINETS ATTACHING & LINKING PACK

	INTERNAL LINKING PACK	
	Commercial Ref. 48111	<i>Internal linking pack (6 units)</i>
	CORNER LINKING PACK	
	Commercial Ref. 48112	<i>Corner linking pack (4 units)</i>
	LINKING & LIFTING PACK	
	Commercial Ref. 48114	<i>Linking & lifting pack (2 units)</i>
	WALL ATTACHMENT PACK	
	Commercial Ref. 48113	<i>Wall attachment pack (2 units)</i>

Dimensions in mm

CORNER MODULES



Commercial Ref.	Dimensions (Height x Width x Depth)	For Corners	
		Depth 1	Depth 2
ESQ1804040	1.800x400x400	400x400	
ESQ1804050	1.800x400x500	400x500	500x400
ESQ1804060	1.800x400x600	400x600	600x400
ESQ1805050	1.800x500x500	500x500	
ESQ1805060	1.800x500x600	500x600	600x500
ESQ1806060	1.800x600x600	600x600	
ESQ2004040	2.000x400x400	400x400	
ESQ2004050	2.000x400x500	400x500	500x400
ESQ2004060	2.000x400x600	400x600	600x400
ESQ2004080	2.000x400x800	400x800	800x400
ESQ2005050	2.000x500x500	500x500	
ESQ2005060	2.000x500x600	500x600	600x500
ESQ2005080	2.000x500x800	500x800	800x500
ESQ2006050	2.000x600x500	600x500	500x600
ESQ2006060	2.000x600x600	600x600	
ESQ2006080	2.000x600x800	600x800	800x600
ESQ2008080	2.000x800x800	800x800	

AUXILIARY MODULE



Commercial Ref.	Dimensions (AxBxC)	For Cabinets
		(Height x Depth)
MEX1804040	1.800x400x400	1.800x400
MEX1804050	1.800x400x500	1.800x500
MEX1804060	1.800x400x600	1.800x600
MEX2004040	2.000x400x400	2.000x400
MEX2004050	2.000x400x500	2.000x500
MEX2004060	2.000x400x600	2.000x600
MEX2004080	2.000x400x800	2.000x800
MEX2204060	2.200x400x600	2.200x600
MEX2204080	2.200x400x800	2.200x800

COVER FOR AUXILIARY MODULE



Commercial Ref.	
TCF3040	Blanking cover for 300x400 auxiliary module
TCF4040	Blanking cover for 400x400 auxiliary module
TCF6040	Blanking cover for 600x400 auxiliary module
TCF16040	Blanking cover for 1.600x400 auxiliary module
TCF18040	Blanking cover for 1.800x400 auxiliary module

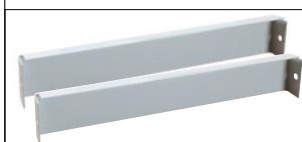

Commercial Ref.	
48642	Upper-lower cover for auxiliary module (2 pcs.)

ARGENTA PLUS accessories

BUS-BAR ENCLOSURE

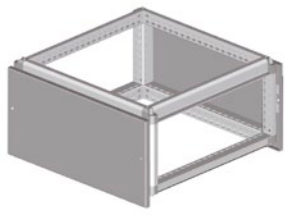

Commercial Ref.	Dimensions (Height x Width x Depth)	
	CE304060	300x400x600
CE304080	300x400x800	
CE306060	300x600x600	
CE306080	300x600x800	
CE308060	300x800x600	
CE308080	300x800x800	
CE3010060	300x1.000x600	
CE3010080	300x1.000x800	
CE3012060	300x1.200x600	
CE3012080	300x1.200x800	

SIDE PANELS FOR BUS-BAR ENCLOSURE

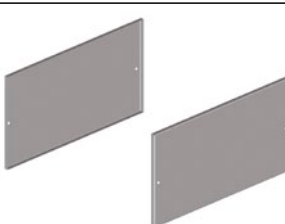

Commercial Ref.	
PLCE600	300x600 panels (2 pcs.)
PLCE800	300x800 panels (2 pcs.)

MODULAR FRAME



MODULAR FRAME FOR 600 & 800 MM-WIDTH CABINETS

Comprises two vertical and two horizontal profiles; needed for the assembly of modular covers.

Commercial Ref.	Height useful space	For cabinet (Height x Width)	
		BTM16560	1.450
BTM16580	1.450	1.650	800
BTM18060	1.600	1.800	600
BTM18080	1.600	1.800	800
BTM20060	1.800	2.000	600
BTM20080	1.800	2.000	800
BTM22080	2.000	2.200	800



MODULAR FRAME FOR 1.000 & 1.200 MM-WIDTH CABINETS

Comprises four vertical profiles, two horizontal profiles and a dividing door; needed for the assembly of modular covers.

Commercial Ref.	Height useful space	For cabinet (Height x Width)	
		BTM165100	1.450
BTM165120	1.450	1.650	1.200
BTM180100	1.600	1.800	1.000
BTM180120	1.600	1.800	1.200
BTM200100	1.800	2.000	1.000
BTM200120	1.800	2.000	1.200

accessories ARGENTA PLUS

SWING FRAME FOR 19" RACK ■



Commercial Ref.	Assembly units	Dimensions (Height x Width x Depth)
BP19/36U	36U	1.800x800x600
BP19/40U	40U	2.000x800x600/800
BP19/45U	45U	2.200x800x600/800

FIXED FRAME FOR 19" RACK ■

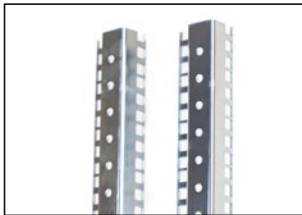

FIXED FRAME PROFILE

Commercial Ref.	Assembly units	For Cabinet
BF19/39U	19" 39U fixed frame profile (2 pcs.)	1.800x600/800
BF19/43U	19" 43U fixed frame profile (2 pcs.)	2.000x600/800
BF19/48U	19" 48U fixed frame profile (2 pcs.)	2.200x600/800

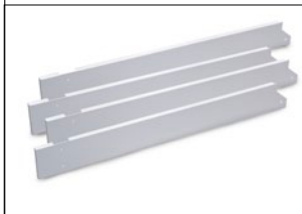

FINISHING LIDS

Commercial Ref.		
EBF19/39U	19" 39U end cap (4 pcs.)	
EBF19/43U	19" 43U end cap (4 pcs.)	
EBF19/48U	19" 48U end cap (4 pcs.)	



FIXING BRACKETS

Commercial Ref.	Unidades de montaje
SBF19	Bracket for 19" fixed frame profile (2 pcs.)

COVERS FOR 19" RACK FRAME ■



BLANK COVERS

Commercial Ref.	
TCB1U	1U blank cover frame
TCB2U	2U blank cover frame
TCB3U	3U blank cover frame
TCB4U	4U blank cover frame
TCB6U	6U blank cover frame
TCB9U	9U blank cover frame
TCB10U	10U blank cover frame
TCB12U	12U blank cover frame

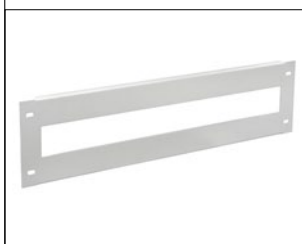

MODULAR COVERS

Commercial Ref.	
TMB3U	3U (24 modules) modular cover frames

ARGENTA PLUS accessories

MODULAR COVERS

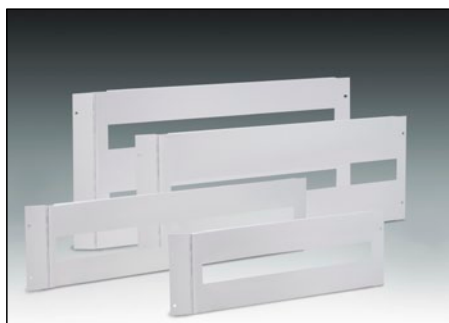

MODULAR HINGED COVERS

Commercial Ref.	Dimensions (Height x Width)		No. modules
TMA1560	150	600	20
TMA1580	150	800	30
TMA2060	200	600	20
TMA2080	200	800	30
TMA3060	300	600	2x20
TMA3080	300	800	2x30
TMA4060	400	600	2x20
TMA4080	400	800	2x30



BLANK HINGED COVERS

Commercial Ref.	Dimensions (Height x Width)		
TCA1560	150	600	
TCA1580	150	800	
TCA2060	200	600	
TCA2080	200	800	
TCA3060	300	600	
TCA3080	300	800	
TCA4060	400	600	
TCA4080	400	800	
TCA6060	600	600	
TCA6080	600	800	

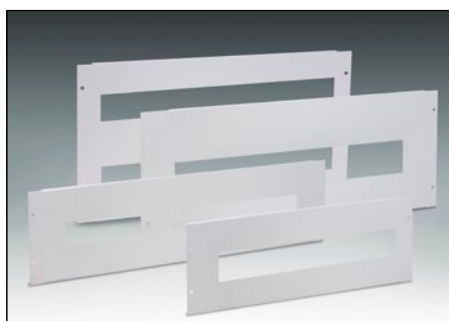

MODULAR FIXED COVERS

Commercial Ref.	Dimensions (Height x Width)		No. modules
TMF1560	150	600	20
TMF1580	150	800	30
TMF2060	200	600	20
TMF2080	200	800	30
TMF3060	300	600	2x20
TMF3080	300	800	2x30
TMF4060	400	600	2x20
TMF4080	400	800	2x30



BLANK FIXED COVERS

Commercial Ref.	Dimensions (Height x Width)		
TCF0560	50	600	
TCF0580	50	800	
TCF1060	100	600	
TCF1080	100	800	
TCF1560	150	600	
TCF1580	150	800	
TCF2060	200	600	
TCF2080	200	800	
TCF3060	300	600	
TCF3080	300	800	
TCF4060	400	600	
TCF4080	400	800	
TCF6060	600	600	
TCF6080	600	800	

ASSEMBLY SUPPORTS + DIN RAIL



Commercial Ref.

48154	Attachment kit + 600 mm DIN rail
48156	Attachment kit + 800 mm DIN rail

See more references on page 107

TRUNKING SUPPORT KIT



Commercial Ref.

49366	600 mm vertical trunking support
49367	800 mm vertical trunking support



Commercial Ref.

49368	Horizontal trunking support (2 pcs. bag)
--------------	--

INSULATING JOINTS



INSULATING JOINT FOR LINKING CABINETS

Commercial Ref.

48478	Light grey-coloured finishing corner (6 m)
--------------	--



Commercial Ref.

48479	Insulation gasket for joined cabinets (6 m)
--------------	---



Commercial Ref.

48480	Adhesive insulation gasket for joined cabinets (6 m)
--------------	--



INSULATING JOINT FOR CABLE ENTRY

Commercial Ref.

48481	Insulating brush for cable entry (2 m)
--------------	--

SLIDEWAY

Commercial Ref.

48500	Plate union pack
GD400	Pack 400 mm slideway
GD600	Pack 600 mm slideway
GD800	Pack 800 mm slideway
GD1000	Pack 1.000 mm slideway
GD1200	Pack 1.200 mm slideway

ARGENTA PLUS accessories

■ PLINTH



CORNERS & FRONT COVERS

Commercial Ref.

100 PLINTH		Cabinet width
ZCL1040	100	400
ZCL1050	100	500
ZCL1060	100	600
ZCL1080	100	800
ZCL10100	100	1.000
ZCL10120	100	1.200
200 PLINTH		
ZCL2040	200	400
ZCL2050	200	500
ZCL2060	200	600
ZCL2080	200	800
ZCL20100	200	1.000
ZCL20120	200	1.200
200 PLINTH (Plinth 100 + 100)		
ZCL2T1040	100 + 100	400
ZCL2T1050	100 + 100	500
ZCL2T1060	100 + 100	600
ZCL2T1080	100 + 100	800
ZCL2T10100	100 + 100	1.000
ZCL2T10120	100 + 100	1.200



SIDE COVERS

Commercial Ref.

100 PLINTH		Cabinet depth
TLZCL1040	100	400
TLZCL1050	100	500
TLZCL1060	100	600
TLZCL1080	100	800
200 PLINTH		
TLZCL2040	200	400
TLZCL2050	200	500
TLZCL2060	200	600
TLZCL2080	200	800



MOUNTING PROFILES ■



MOUNTING PROFILES FOR MODULAR FRAME

Commercial Ref.

PMB400	Frame profile for 400 mm-depth cabinet (2 profiles)
PMB500	Frame profile for 500 mm-depth cabinet (2 profiles)
PMB600	Frame profile for 600 mm-depth cabinet (2 profiles)
PMB800	Frame profile for 800 mm-depth cabinet (2 profiles)



EXTERNAL MOUNTING PROFILES

Commercial Ref.

PME400	External profile for 400 mm-depth cabinet (2 profiles)
PME500	External profile for 500 mm-depth cabinet (2 profiles)
PME600	External profile for 600 mm width and depth cabinet (2 profiles)
PME800	External profile for 800 mm width and depth cabinet (2 profiles)
PME1000	External profile for 1.000 mm width cabinet (2 profiles)
PME1200	External profile for 1.200 mm width cabinet (2 profiles)
PME1650	External profile for 1.650 mm height cabinet (2 profiles)
PME1800	External profile for 1.800 mm height cabinet (2 profiles)
PME2000	External profile for 2.000 mm height cabinet (2 profiles)



INTERNAL MOUNTING PROFILES

Commercial Ref.

PMI400	Internal profile for 400 mm-depth cabinet (2 profiles)
PMI500	Internal profile for 500 mm-depth cabinet (2 profiles)
PMI600	Internal profile for 600 mm width and depth cabinet (2 profiles)
PMI800	Internal profile for 800 mm width and depth cabinet (2 profiles)
PMI1000	Internal profile for 1.000 mm width cabinet (2 profiles)
PMI1200	Internal profile for 1.200 mm width cabinet (2 profiles)
PMI1650	Internal profile for 1.650 mm height cabinet (2 profiles)
PMI1800	Internal profile for 1.800 mm height cabinet (2 profiles)
PMI2000	Internal profile for 2.000 mm height cabinet (2 profiles)

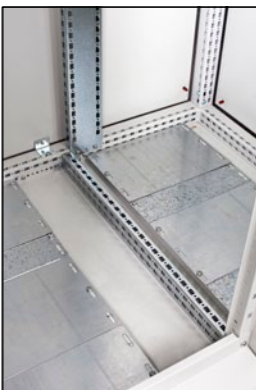

INTERIOR PARTITION PROFILE

Commercial Ref.

PPI400	Partition profile for cabinet, depth 400 mm (2 profiles)
PPI500	Partition profile for cabinet, depth 500 mm (2 profiles)
PPI600	Partition profile for cabinet, depth 600 mm (2 profiles)
PPI800	Partition profile for cabinet, depth 800 mm (2 profiles)

ARGENTA PLUS accessories

DOORS



SINGLE DOORS OPAQUE

Commercial Ref.	For cabinet (Height x Width)	
PO16560	1.650	600
PO16580	1.650	800
PO165100	1.650	1.000
PO18060	1.800	600
PO18080	1.800	800
PO180100	1.800	1.000
PO20060	2.000	600
PO20080	2.000	800
PO200100	2.000	1.000

TRANSPARENT

PT16560	1.650	600
PT16580	1.650	800
PT18060	1.800	600
PT18080	1.800	800
PT20060	2.000	600
PT20080	2.000	800



SYMMETRICAL OPAQUE DOUBLE DOORS

Two doors by ref. no. with double internal lock

Cabinet of 1.000: PO500 + PO500

Cabinet of 1.200: PO600 + PO600

SYMMETRICAL

Commercial Ref.	For cabinet (Height x Width)	
PODCS165100	1.650	1.000
PODCS165120	1.650	1.200
PODCS180100	1.800	1.000
PODCS180120	1.800	1.200
PODCS200100	2.000	1.000
PODCS200120	2.000	1.200



ASYMMETRICAL TRANSPARENT DOUBLE DOORS

Two doors by ref. no. with double internal lock

Cabinet of 1.000: PT600 + PO400

Cabinet of 1.200: PT800 + PO400

ASYMMETRICAL

Commercial Ref.	For cabinet (Height x Width)	
PTDCA165100	1.650	1.000
PTDCA165120	1.650	1.200
PTDCA180100	1.800	1.000
PTDCA180120	1.800	1.200
PTDCA200100	2.000	1.000
PTDCA200120	2.000	1.200

INTERNAL DOORS ■



Commercial Ref.

For cabinet (Height x Width)

PIN16560	1.650	600
PIN16580	1.650	800
PIN18040	1.800	400
PIN18060	1.800	600
PIN18080	1.800	800
PIN20040	2.000	400
PIN20060	2.000	600
PIN20080	2.000	800

MOUNTING PROFILES FOR DOORS ■

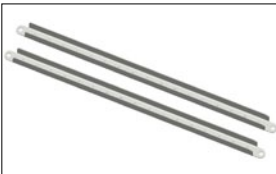

Referencia

PPAP600	600 mm mounting profile
PPAP800	800 mm mounting profile
PPAP1000	1.000 mm mounting profile

PC TRAY ■

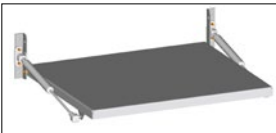

Referencia

48776	PC Tray
-------	---------

LOCKS ■



Commercial Ref.

48463	Triangular insert closure 7 + triangular key
-------	--

Commercial Ref.

48464	Keyless pressure insert lock
-------	------------------------------

Commercial Ref.

48465	Safety insert lock with key
-------	-----------------------------

Commercial Ref.

48460	Zamak double-bit key 5
-------	------------------------

PACKS FOR DOORS ■



Commercial Ref.

48483	Double-door inside lock + rod 1.650
-------	-------------------------------------

48484	Double-door inside lock + rod 1.800
-------	-------------------------------------

48485	Double-door inside lock + rod 2.000
-------	-------------------------------------



Commercial Ref.

48461	Pack of hinge (4 units)
-------	-------------------------

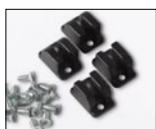

Commercial Ref.

48482	Pack of lock retainer (4 units)
-------	---------------------------------